

# PhlatLight<sup>®</sup> LED Illumination Products

## CBM-380 Series

### Features

- Extremely high optical output:
  - up to 700 Red lumens
  - up to 2,000 Green lumens
  - up to 300 Blue lumens
  - up to 1,600 White lumens
- High thermal conductivity package - junction to heat sink thermal resistance as low as 0.8 °C/W per die
- Photonic lattice technology for very high surface brightness and uniform emission
- Large, monolithic chip with emitting area of up to 12 mm<sup>2</sup>
- High luminous efficacy
- Lumen maintenance of greater than 70% after 60,000 hours
- Environmentally friendly: RoHS compliant
- Variable drive currents: less than 1 A through 12 A to full reliability specifications
- Available in RGBW combination

### Applications

- Entertainment
- Architectural Lighting
- Medical Lighting
- Spot Lighting
- Fiber Coupled Illumination
- Emergency Vehicle Lighting
- Machine Vision
- Displays and Signage
- General Illumination



*PhlatLight<sup>®</sup> LEDs, based on Photonic Lattice Technology, enable a new class of illumination applications.*

### Table of Contents

Technology Overview.....	2
Test Specifications.....	2
Binning Information.....	3
Shipping and Labeling Information .....	6
Optical and Electrical Characteristics .....	7
Common Characteristics and Notes .....	11
Flux and Spectral Characteristics vs. Temperature .....	12
Lifetime and Lumen Maintenance .....	12
Radiation Patterns .....	13
Thermal Resistance .....	13
Mechanical Dimensions.....	14
Ordering Information .....	15

## Technology Overview

PhlatLight LEDs benefit from a suite of innovations in the fields of chip technology, packaging, and thermal management. These breakthroughs allow illumination designers to achieve efficient light engine designs and deliver high brightness solutions.

### PhlatLight Technology

The name PhlatLight is derived from Photonic Lattice. PhlatLight devices use photonic lattice patterns to extract more light from the LED chip.

Photonic lattice technology creates true surface emission from the source, which enables large area LED chips with uniform brightness over the entire LED chip surface. The optical power and brightness produced by these large monolithic chips enable solutions which replace arc and halogen lamps where arrays of traditional high power LEDs cannot.

In addition, PhlatLight technology can create radiation patterns that are collimated compared to typical Lambertian emitters. Optical collection efficiencies improve and optical designs become simplified with a more collimated light source.

### Packaging Technology

Thermal management is critical in high power LED applications. With a thermal resistance from junction to heat sink of 0.8 °C/W per chip, PhlatLight CBM-380 devices have the lowest thermal resistance of any LED on the market. This allows operation at higher current densities while maintaining a low junction temperature, thereby resulting in brighter and longer lifetimes. The package is easy to use, and ready to be mounted in the lighting system.

### Reliability

Designed from the ground up, PhlatLight LEDs are one of the most reliable light sources in the world today. PhlatLight LEDs have passed a rigorous suite of environmental and mechanical stress tests, including mechanical shock, vibration, temperature cycling and humidity, and have been fully qualified for use in extreme high power and high current applications. With very low failure rates and median lifetimes that are well above 60,000 hours, PhlatLight LEDs are ready for the most demanding applications.

### Environmental Benefits

PhlatLight LEDs help reduce power consumption and the amount of hazardous waste entering the environment. All PhlatLight products manufactured by Luminus are RoHS compliant and free of hazardous materials, including lead and mercury.

## Understanding PhlatLight Test Specifications

Every PhlatLight LED device is fully tested to ensure that it meets the high quality standards of Luminus' products.

### Testing Temperature

PhlatLight LEDs are measured in such a way that the characteristics reported agree with how the devices will actually perform when incorporated into a system. This measurement is accomplished by mounting the devices on a 40° C heat sink and allowing the device to reach thermal equilibrium while fully powered. Only after the device reaches equilibrium are the measurements taken. This method of measurement ensures that PhlatLight LEDs perform in the field just as they are specified.

### Multiple Operating Points

The tables on the following pages provide typical optical and electrical characteristics. Since the LEDs can be operated over a wide range of drive conditions (currents from <1 A to 12 A, and duty cycles from <1% to 100%) multiple drive conditions are listed.

The actual operating condition will depend upon the application, flux requirements, thermal design, and other detailed system parameters.

PhlatLight CBM-380 Bins

PhlatLight CBM-380 LEDs are specified for luminous flux and wavelength at different drive conditions for each color. Red and green are specified at 12 A (1.0 A/mm<sup>2</sup>), blue is specified at 8.1 A (1.5 A/mm<sup>2</sup>) and white is specified at 9.0 A (1.0A/mm<sup>2</sup>). Once tested, devices are placed into one of the following luminous flux (FF) and wavelength (WW) bins:

Blue Bins

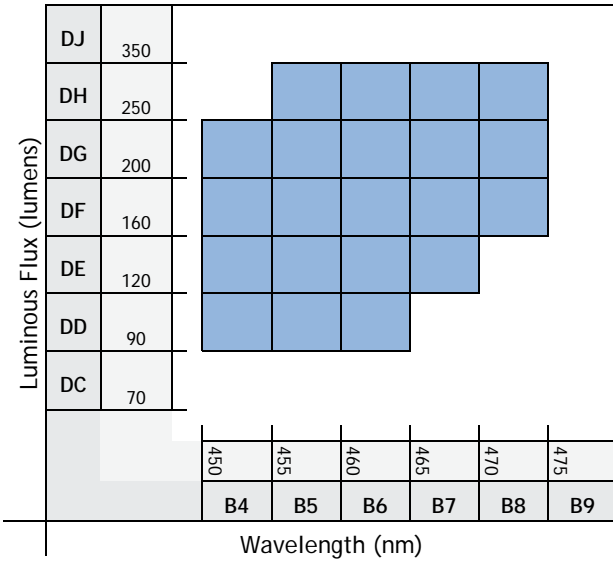

Green Bins

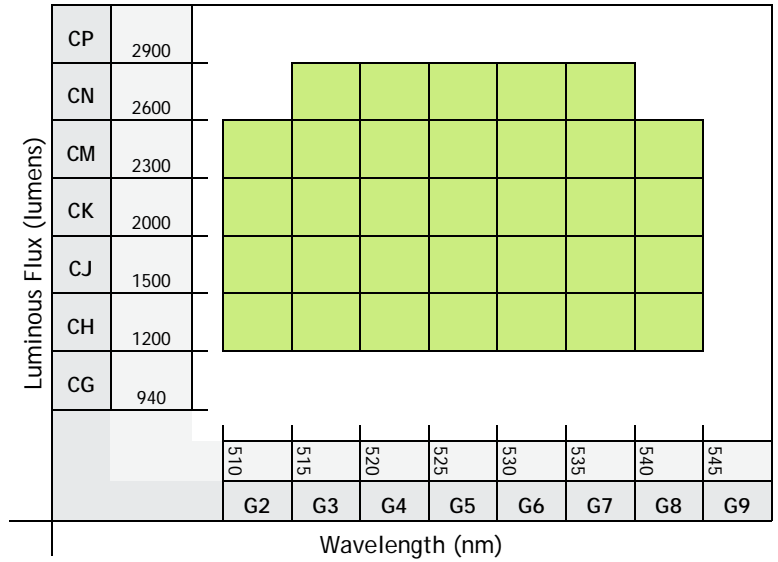

Red Bins

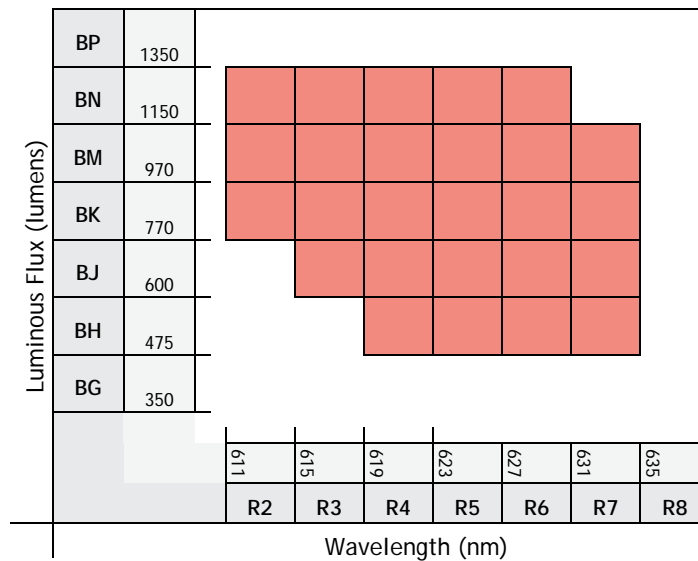

White Binning Structure  
Flux Bins

Flux Bin Code (FF)	Minimum Luminous Flux @ I <sub>F</sub> = 9.0 A	Maximum Luminous Flux @ I <sub>F</sub> = 9.0 A
WN	1,000	1,200
WP	1,200	1,450
WQ	1,450	1,750
WR	1,750	2,100

Chromaticity Bins

6500K Chromaticity Bins		
Bin Code (WW)	CIEx	CIEy
DG	0.307	0.311
	0.322	0.326
	0.323	0.316
	0.309	0.302
F3	0.305	0.321
	0.313	0.329
	0.315	0.319
	0.307	0.311
F4	0.303	0.330
	0.312	0.339
	0.313	0.329
	0.305	0.321
G3	0.313	0.329
	0.321	0.337
	0.322	0.326
	0.315	0.319
G4	0.312	0.339
	0.321	0.348
	0.321	0.337
	0.313	0.329
EF	0.302	0.335
	0.320	0.354
	0.321	0.348
	0.303	0.330
DE	0.283	0.304
	0.303	0.330
	0.307	0.311
	0.289	0.293
DF	0.289	0.293
	0.307	0.311
	0.309	0.302
	0.293	0.285

5700K Chromaticity Bins		
Bin Code (WW)	CIEx	CIEy
DJ	0.322	0.324
	0.337	0.337
	0.336	0.326
	0.323	0.314
H3	0.321	0.335
	0.329	0.342
	0.329	0.331
	0.322	0.324
H4	0.321	0.346
	0.329	0.354
	0.329	0.342
	0.321	0.335
J3	0.329	0.342
	0.337	0.349
	0.337	0.337
	0.330	0.331
J4	0.329	0.354
	0.338	0.362
	0.337	0.349
	0.329	0.342
EH	0.320	0.352
	0.338	0.368
	0.338	0.362
	0.321	0.346

Luminus' Standard Chromaticity Bins: 1931 CIE Curve

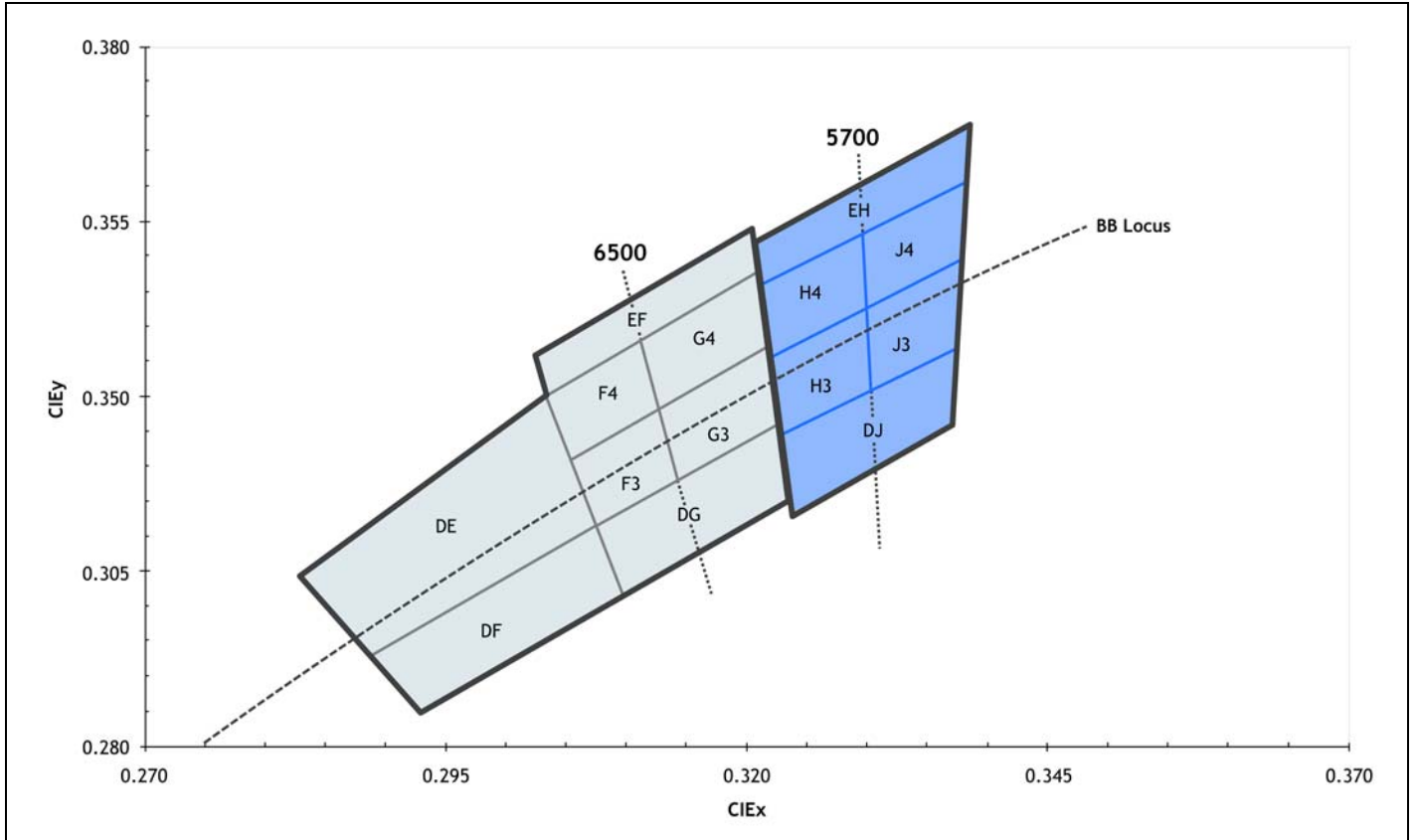

### PhlatLight Product Shipping and Labeling Information

All PhlatLight CBM-380 products are packaged and labeled with their respective bin as outlined in the tables on page 3 and 4. Modules are packaged in trays of 10, with each package only containing one bin. The part number designation is as follows:

CBM — 380 — RGBW — D11 — XXXX

Product Family	Chip Area	Color	Package Configuration	Bin Kit
CBM: Windowed Chip on Board	380: 38mm <sup>2</sup>	R: Red G: Green B: Blue W: White	D11: 32 x 32 mm board	XXXX: Bin kit as denoted on pages 15

Note: Some flux and wavelength bins may have limited availability. Application specific bin kits, consisting of multiple bins, may be available. Please consult the CBM-380-RGBW binning and labeling document for further information. For ordering information, please refer to page 15 or contact your local Luminus sales representative.

Optical and Electrical Characteristics ( $T_{\text{heat sink}} = 40\text{ }^{\circ}\text{C}$ )<sup>1</sup>

Red				
Drive Condition <sup>2</sup>		4.2 A Continuous	12 A Continuous	
Parameter	Symbol	Values <sup>3</sup>	Values	Unit
Current Density	j	0.35	1.0	A/mm <sup>2</sup>
Forward Voltage	$V_{F \text{ min}}$		2.0	V
	$V_{F \text{ typ}}$	2.2	2.5	V
	$V_{F \text{ max}}$		3.0	V
Luminous Flux <sup>4</sup>	$\Phi_V \text{ typ}$	260	600	lm
Dominant Wavelength	$\lambda_d$	622	624	nm
FWHM	$\Delta\lambda_{1/2}$	16	18	nm
Chromaticity Coordinates <sup>5,6</sup>	x	0.697	0.700	-
	y	0.303	0.300	-

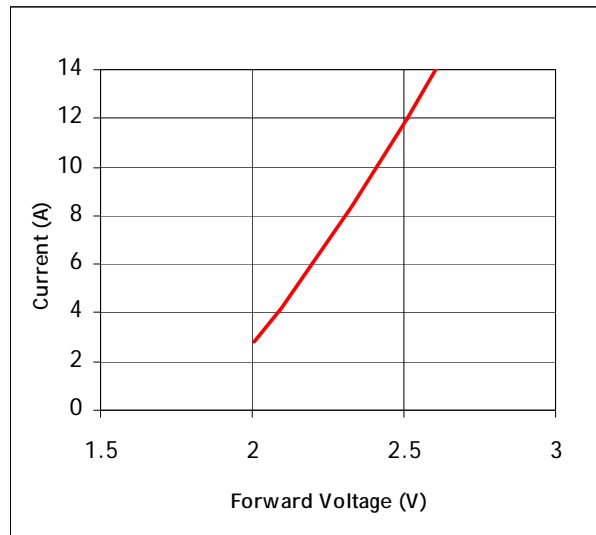
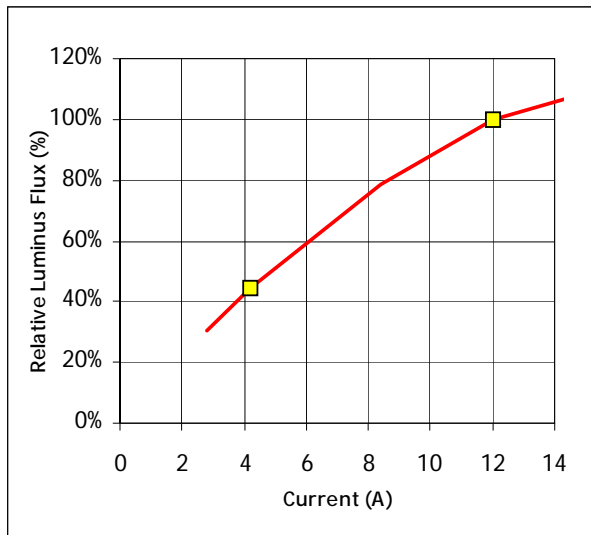

Yellow squares indicate reference drive conditions

Optical and Electrical Characteristics ( $T_{\text{heat sink}} = 40\text{ }^{\circ}\text{C}$ )<sup>1</sup>

Green				
Drive Condition <sup>2</sup>		4.2 A Continuous	12 A Continuous	
Parameter	Symbol	Values <sup>3</sup>	Values	Unit
Current Density	j	0.35	1.0	A/mm <sup>2</sup>
Forward Voltage	$V_{F \text{ min}}$		3.5	V
	$V_{F \text{ typ}}$	3.5	4.0	V
	$V_{F \text{ max}}$		4.9	V
Luminous Flux <sup>4</sup>	$\Phi_V \text{ typ}$	800	1700	lm
Dominant Wavelength	$\lambda_d$	537	533	nm
FWHM	$\Delta\lambda_{1/2}$	35	38	nm
Chromaticity Coordinates <sup>5,6</sup>	x	0.223	0.196	-
	y	0.720	0.709	-

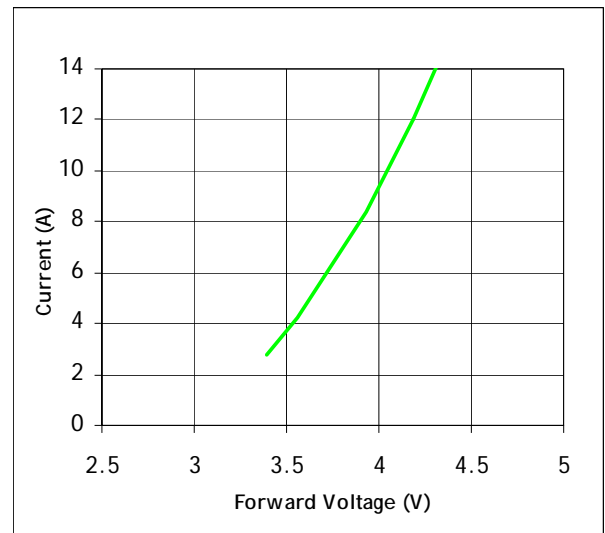
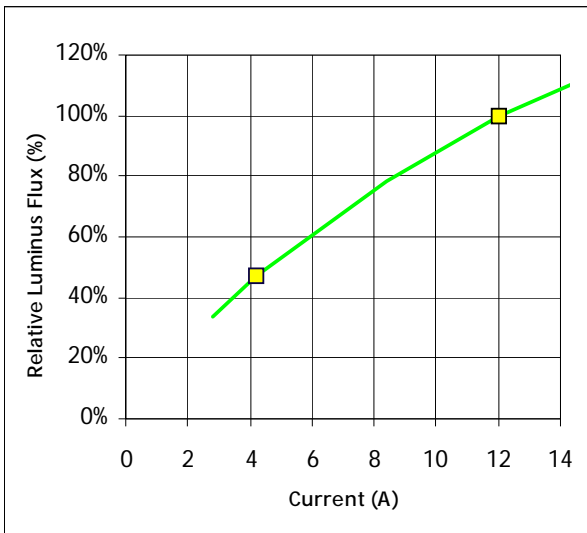

Yellow squares indicate reference drive conditions

Optical and Electrical Characteristics ( $T_{\text{heat sink}} = 40\text{ }^{\circ}\text{C}$ )<sup>1</sup>

Blue				
Drive Condition <sup>2</sup>		1.9 A Continuous	8.1 A Continuous	
Parameter	Symbol	Values <sup>3</sup>	Values	Unit
Current Density	j	0.35	1.5	A/mm <sup>2</sup>
Forward Voltage	V <sub>F min</sub>		3.5	V
	V <sub>F typ</sub>	3.4	4.1	V
	V <sub>F max</sub>		5.0	V
Luminous Flux <sup>4</sup>	Φ <sub>V typ</sub>	70	190	lm
Dominant Wavelength	λ <sub>d</sub>	465	464	nm
FWHM	Δλ <sub>1/2</sub>	21	24	nm
Chromaticity Coordinates <sup>5,6</sup>	x	0.139	0.140	-
	y	0.047	0.049	-

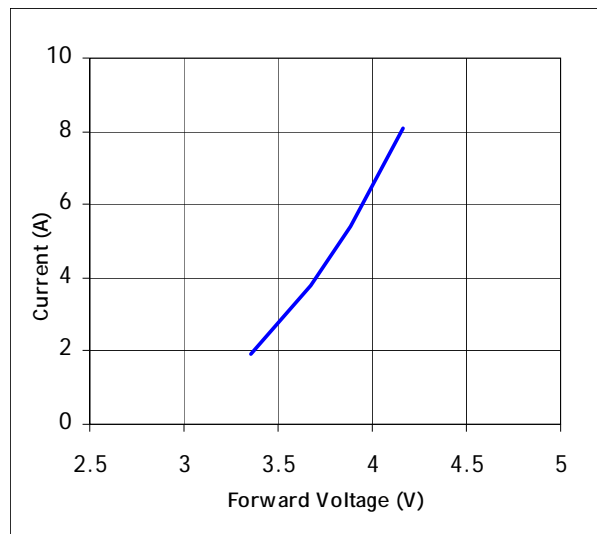
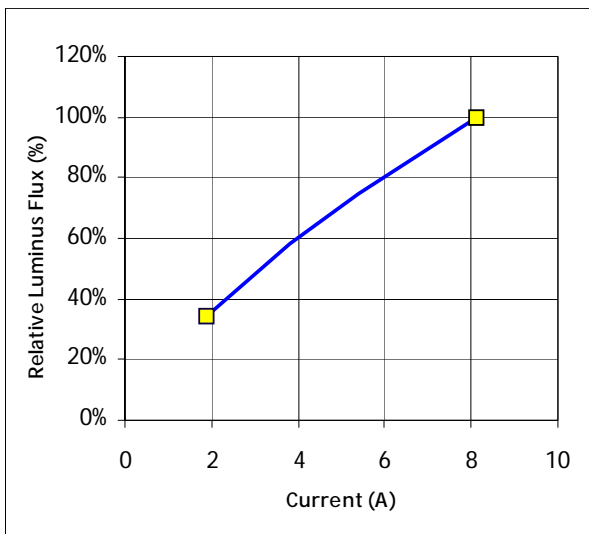

Yellow squares indicate reference drive conditions

Optical and Electrical Characteristics ( $T_{\text{heat sink}} = 40\text{ }^{\circ}\text{C}$ )<sup>1</sup>

White				
Drive Condition <sup>2</sup>		3.2 A Continuous	9.0 A Continuous	
Parameter	Symbol	Values <sup>3</sup>	Values	Unit
Current Density	j	0.35	1.0	A/mm <sup>2</sup>
Forward Voltage	V <sub>F min</sub>		3.1	V
	V <sub>F typ</sub>	3.1	3.6	V
	V <sub>F max</sub>		4.6	V
Luminous Flux <sup>4</sup>	Φ <sub>V</sub>	650	1400	lm
Color Temperature	λ <sub>d</sub>	6300	6500	K
Chromaticity Coordinates <sup>5,6</sup>	x	0.317	0.312	-
	y	0.336	0.328	-

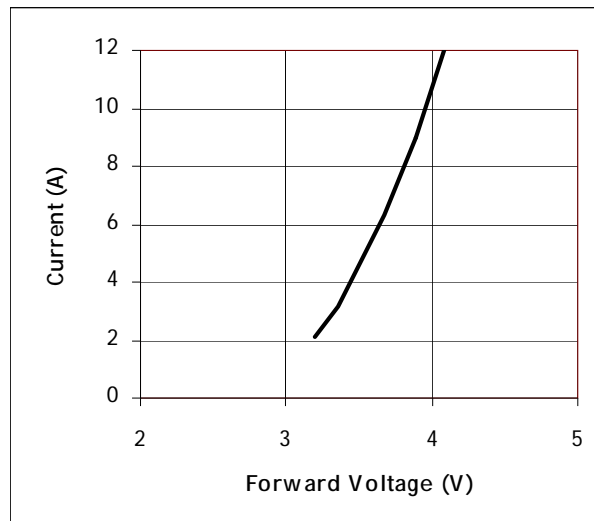
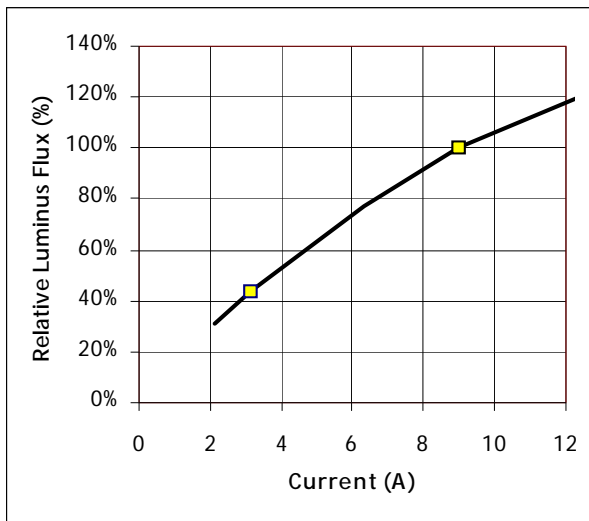

Yellow squares indicate reference drive conditions

Optical and Electrical Characteristics ( $T_{\text{heat sink}} = 40\text{ }^{\circ}\text{C}$ )<sup>1</sup>

Common Characteristics

	Symbol	Red	Green	Blue	White	Unit
Emitting Area		12.0	12.0	5.4	9.0	mm <sup>2</sup>
Emitting Area Dimensions		4.6x2.6	4.6x2.6	2.7x2.0	3.0x3.0	mmxmm
Dynamic Resistance	$\Omega_{\text{dyn}}$	0.05	0.07	0.08	0.08	$\Omega$
Thermal Coefficient of Photometric Flux		-1.14	-0.17	-0.008	-0.20	%/ $^{\circ}\text{C}$
Thermal Coefficient of Radiometric Flux		-0.69	-0.18	-0.13	-0.18	%/ $^{\circ}\text{C}$
Thermal Coefficient of Junction Voltage		-2.1	-3.9	-5.1	-4.5	mV/ $^{\circ}\text{C}$

Absolute Maximum Ratings

	Symbol	Red	Green	Blue	White	Unit
Maximum Current <sup>7</sup>		12	12	8.1	9	A
Maximum Junction Temperature <sup>8</sup>	$T_{\text{jmax}}$	125	150	150	150	$^{\circ}\text{C}$
Storage Temperature Range		-40/+100	-40/+100	-40/+100	-40/+100	$^{\circ}\text{C}$
Maximum Total Current (RMS) <sup>9,10</sup>		32				A

- Note 1: All ratings are based on operation with a constant heat sink temperature  $T_{\text{hs}} = 40^{\circ}\text{C}$ . See Thermal Resistance section for  $T_{\text{hs}}$  definition.
- Note 2: Listed drive conditions are typical for common applications. PhlatLight RGBW devices can be driven at currents ranging from <1 A to 8-12 A depending on color and at duty cycles ranging from 1% to 100%. Drive current and duty cycle should be adjusted as necessary to maintain the junction temperature desired to meet application lifetime requirements.
- Note 3: Unless otherwise noted, values listed are typical. Devices are production tested and specified at 1.0A/mm<sup>2</sup> for red, green and white and 1.5A/mm<sup>2</sup> for blue. Other values are for reference only.
- Note 4: Total flux from emitting area at listed dominant wavelength. Reported performance is included to show trends for a selected power level. For specific minimum and maximum values, use bin tables. For product roadmap and future performance of devices, contact Luminus.
- Note 5: In CIE 1931 chromaticity diagram coordinates, normalized to X+Y+Z=1.
- Note 6: For reference only.
- Note 7: Luminus PhlatLight LEDs are designed for operation to an absolute maximum current as specified above. Product lifetime data is specified at recommended forward drive currents. Sustained operation at or beyond absolute maximum currents will result in a reduction of device lifetime compared to recommended forward drive currents. Actual device lifetimes will also depend on junction temperature. Refer to the lifetime derating curves for further information. In pulsed operation, rise time from 10-90% of forward current should be larger than 0.5 microseconds.
- Note 8: Lifetime dependent on LED junction temperature. Input power and thermal system must be properly managed to ensure lifetime. See charts on pg 11 for further information.
- Note 9: Maximum current dependent on board temperature and operating condition. Specified value assumes continuous operation and  $T_{\text{board}} = 60^{\circ}\text{C}$ . See maximum current application note for PWM equivalent maximum currents and derating curve for board temperature.
- Note 10: Max total RMS power allowed in operation. RMS current is defined as  $I_{\text{rms}} = I_{\text{peak}} * \text{sqrt}(\text{duty cycle})$ . Total RMS current through anode is equal to  $I_{\text{anode}} = \text{sqrt}(\text{SUM}(I_{\text{rms}}/I_{\text{color}}))$ . See application note for further information.
- Note 11: Special design considerations must be observed for operation under 1 A. Please contact Luminus for further information.
- Note 12: Caution must be taken not to stare at the light emitted from these LEDs. Under special circumstances, the high intensity could damage the eye.

Light Output and Spectral Characteristics Over Heat Sink Temperature

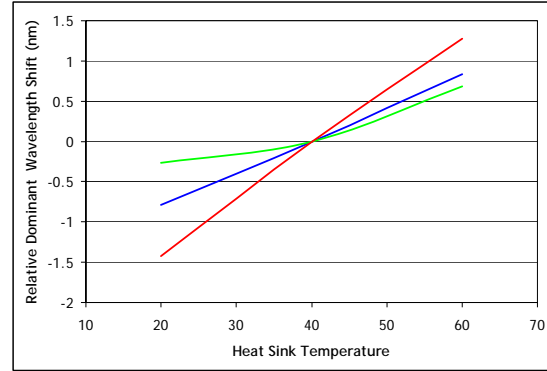
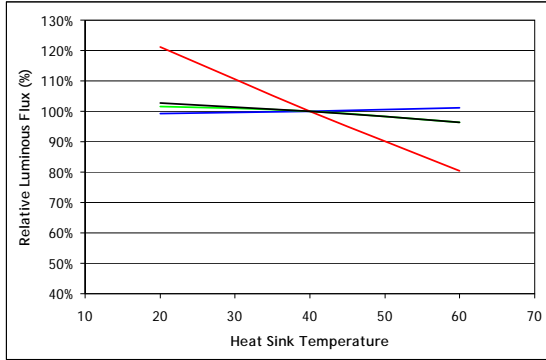

Median Lifetime Estimate vs.  $T_j^{13}$

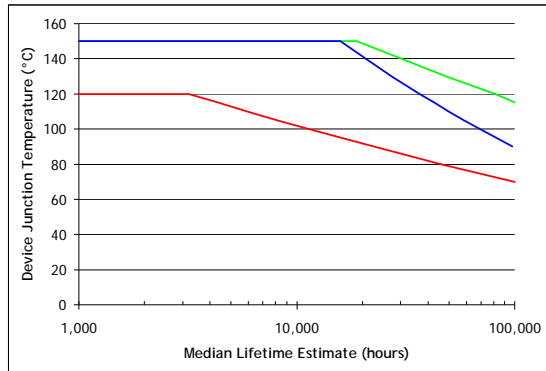

Lumen Maintenance<sup>14</sup>

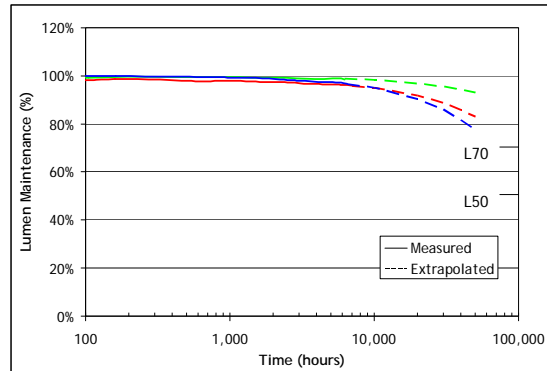

Typical Spectrum<sup>15</sup>

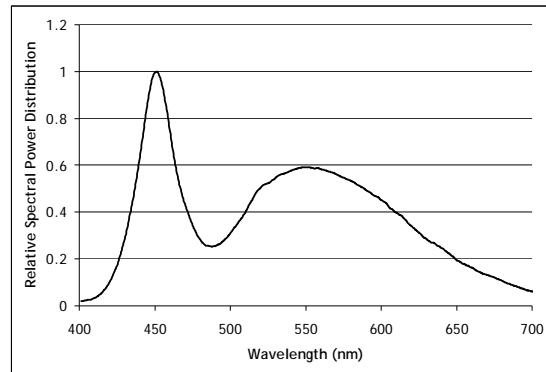
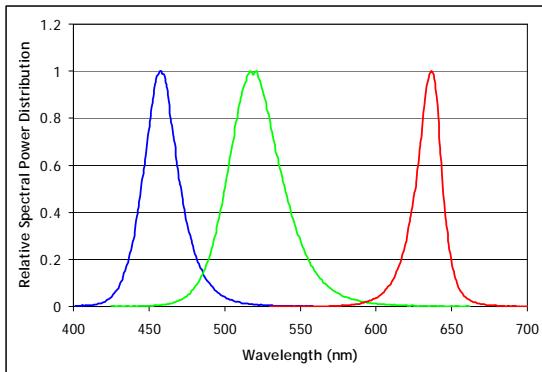

Note 13. Median lifetime estimate as a function of junction temperature at  $1.0A/mm^2$  in continuous operation. Lifetime defined as time to 70% of initial intensity. Based on preliminary lifetime test data. Data can be used to model failure rate over typical product lifetime.

Note 14. Lumen maintenance vs. time at  $1.0A/mm^2$  in continuous operation, Red junction temperature of  $70^\circ C$ , Green junction temperatures of  $120^\circ C$ , Blue and White junction temperatures of  $100^\circ C$ .

Note 15. Typical spectrum at current density of  $1.0 A/mm^2$  in continuous operation for white, green and red. Blue at current density of  $1.5 A/mm^2$

### Typical Radiation Pattern

Typical Polar Radiation Pattern for Blue and Green

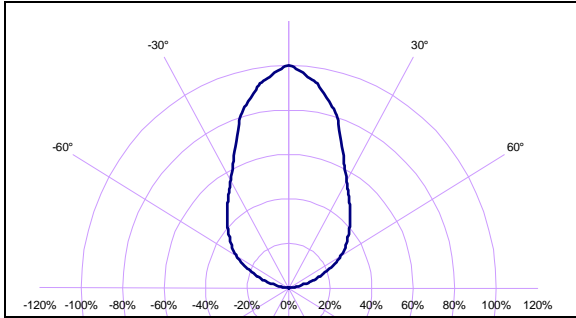

Typical Polar Radiation Pattern for Red and White

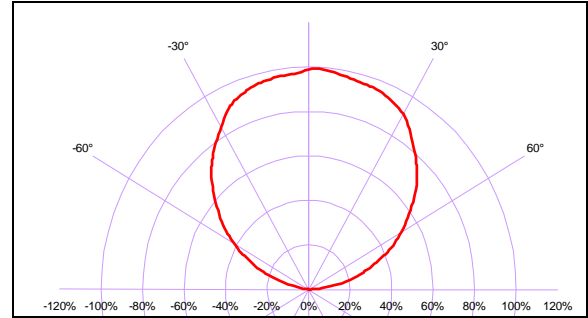

### Thermal Resistance

Diagram illustrating the thermal resistance measurement setup. Key components and nodes are labeled:

- $T_j$ : Die Junction
- $T_b$ : Window
- $T_{hs}$ : Thermistor
- $T_a$ : Heat sink
- Window
- Die Junction
- Window Frame
- Thermistor
- $T_{ref}$ : Copper core-board
- Copper core-board
- Thermal interface material
- Heat sink

$T_{hs}$  definition = 3 mm from core-board

#### Typical Thermal Resistance

Chip	R/G	B	W
$R_{\theta j-hs}^1$	0.80 °C/W	1.20 °C/W	0.83 °C/W
$R_{\theta j-ref}^2$	0.61 °C/W	1.1 °C/W	0.74 °C/W

*Note 1: Thermal Resistance includes eGraf 1205 Thermal interface.*  
*Note 2: Thermal resistance values are based on FEA model results correlated to measure  $R_{\theta j-hs}$  data.*  
*Note 3: Table only for single color operation. Contact Luminus for complete thermal model.*

### Thermistor Information

The thermistor used in PhlatLight devices mounted on core-boards is a 10 kOhm part from Murata Manufacturing Co. The global part number is NCP15XH103J03RC. Please see <http://www.murata.com/> for details on calculating thermistor temperature.

For more information on the use of the thermistor, please contact Luminus directly.

### Electrical Pinout

- 1: Anode (+)
- 2: Red (-)
- 3: Blue (-)
- 4: White (-)
- 5: Green (-)
- 6: Thermistor
- 7: Thermistor
- 8: Anode (+)

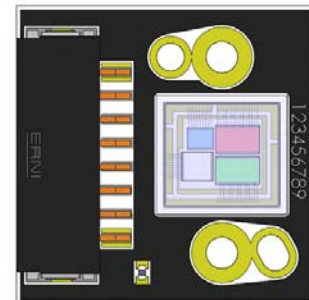

Mechanical Dimensions

DIMENSIONS IN MILLIMETERS

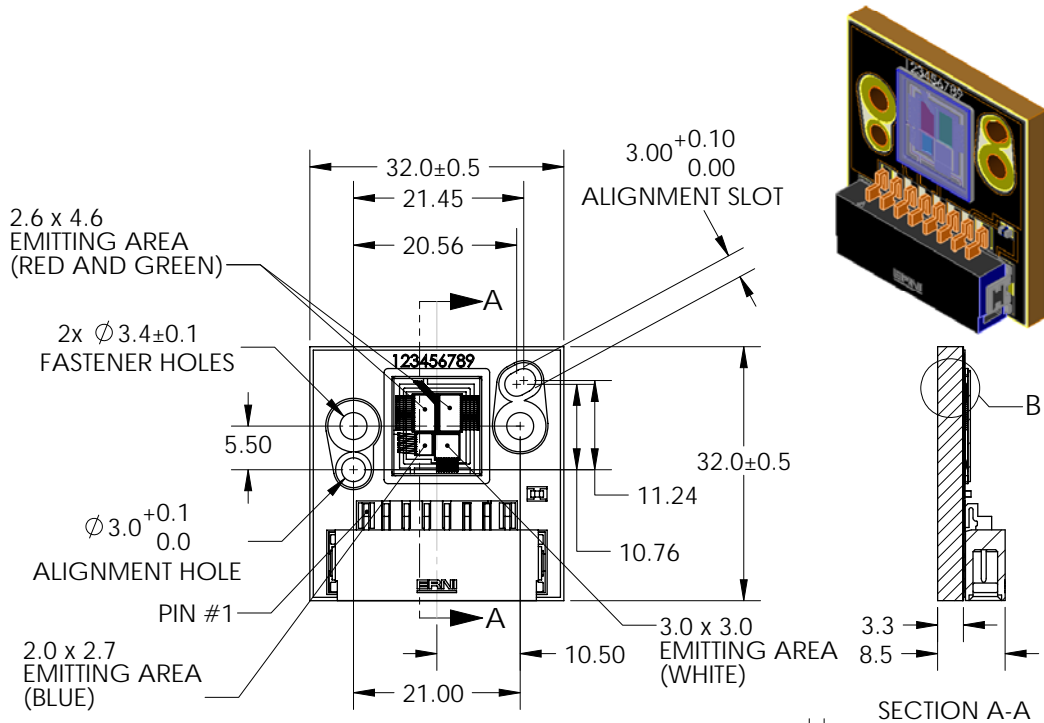

PIN #	DESCRIPTION
1	ANODE
2	CATHODE, RED DIE
3	CATHODE, BLUE DIE
4	CATHODE, WHITE DIE
5	CATHODE, GREEN DIE
6	THERMISTOR
7	THERMISTOR
8	ANODE

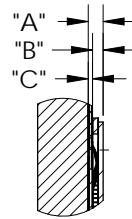

DETAIL B

DIMENSION NAME	DESCRIPTION	NOMINAL DIMENSION	TOLERANCE
"A"	TOP OF SUBSTRATE TO TOP OF GLASS	1.00	±0.13
"B"	EMITTING AREA TO TOP OF GLASS	0.73	±0.16
"C"	TOP OF METAL SUBSTRATE TO EMITTING AREA	0.27	±0.05

For detailed drawing please refer to Luminus drawing #DWG-001288.

Recommended connector: ERNI MaxiBridge p/n 284117. Please refer to page 13 or above for pin-out information.

Ordering Information

Ordering Part Number <sup>1,2,3</sup>	Color	Description
CBM-380-RGBW-D11-QF100	RGBW	PhlatLight CBM-380-RGBW module consisting of a red 12 mm <sup>2</sup> LED, a green 12 mm <sup>2</sup> LED, a blue 5.4 mm <sup>2</sup> LED, a white 9 mm <sup>2</sup> LED, thermistor and connector, mounted on a copper-core PCB

*Note 1: CBM-380-RGBW-D11-QF100 denotes a bin kit comprising of all flux and wavelength bins as listed on page 3 and all flux and chromaticity bins listed on page 4 and 5.*

*Note 2: For info on ordering bin kits, contact your local Luminus sales representative.*

*Note 3: Standard packaging increment (SPI) is 10.*

[www.luminus.com](http://www.luminus.com)

The products, their specifications and other information appearing in this document are subject to change by Luminus Devices without notice. Luminus Devices assumes no liability for errors that may appear in this document, and no liability otherwise arising from the application or use of the product or information contained herein. None of the information provided herein should be considered to be a representation of the fitness or suitability of the product for any particular application or as any other form of warranty. Luminus Devices' product warranties are limited to only such warranties as accompany a purchase contract or purchase order for such products. Nothing herein is to be construed as constituting an additional warranty. No information contained in this publication may be considered as a waiver by Luminus Devices of any intellectual property rights that Luminus Devices may have in such information. PhlatLight<sup>®</sup> is a registered trademark of Luminus Devices, Inc., all rights reserved.

This product is protected by U.S. Patents 6,831,302; 7,074,631; 7,083,993; 7,084,434; 7,098,589; 7,105,861; 7,138,666; 7,166,870; 7,166,871; 7,170,100; 7,196,354; 7,211,831; 7,262,550; 7,274,043; 7,301,271; 7,341,880; 7,344,903; 7,345,416; 7,348,603; 7,388,233; 7,391,059; Patents Pending in the U.S. and other countries.