



PhlatLight® PT120 Projection Chipset

Preliminary

Technology Overview

Luminus Devices' Projection Technology is an innovative solid-state light source created to replace arc lamps in projection systems. Enabled by unique use of Photonic Lattice technology, PhlatLight chipsets represent a major breakthrough in brightness that delivers all the benefits of solid state light sources in projections applications:

- Wide color gamut for vivid colors, exceeds NTSC.
- Instant turn-on, no more wait time.
- High Reliability; no lamp replacement
- Environmentally friendly technology - Mercury-free.
- Electronic control of color points and light intensity on a frame by frame basis

PhlatLight products benefit from numerous innovations in the domain of packaging, thermal management and optical coupling that allow designers to achieve efficient light engine designs and deliver high screen brightness.

Angular Intensity Distribution-Example

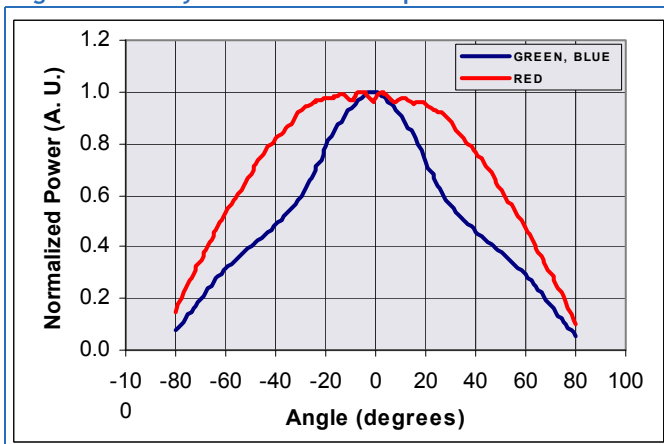

Features

- Matched RGB Chipset with 12mm² emitting area designed for projection applications
- Photonic lattice technology for very high surface brightness
- 100% surface emission for high collection efficiency and low optical losses
- Wide color gamut: RED 623 nm, GREEN 526 nm, BLUE 462 nm typical dominant wavelength
- Single emitting area per color allows for collection with single lens for simplified optics
- 16:9 aspect ratio matched with micro-display and screen aspect ratio
- Over 3575 emitted white lumens at 8000K color temperature from single chipset (Continuous Wave Operation)
- Over 2300 emitted white lumens at 8000K color temperature from single chipset under Pulsed(time sequential) Operation
- Uniform surface emission
- Thermally efficient Type CX Common Anode package
- RoHS (lead-free) compliant

Applications

- Specifically engineered for Rear-Projection Displays, front projectors, head-up projection displays
- Optimized for Micro-Display diagonal sizes ranging from 0.65" to 0.95" with 16:9 aspect ratio.
- Suitable for DLP™ (e.g. xHD5, 0.65", 0.95" 1080p), LCoS, HTPS and 3LCD microdisplays

Optical and Electrical Characteristics

	Symbol	Red	Green	Blue	Unit
Emitting Area		11.96	11.96	11.96	mm ²
Emitting Area Dimensions		4.6x2.6	4.6x2.6	4.6x2.6	mmxmm
Characteristics at recommended Continuous Drive Current I_F (Continuous Waveform)¹					
Recommended Drive Current ²	typ I_F	18	18	18	A
Luminous Flux ³	typ Φ_V	1010	2450	435	lm
Radiometric Flux ³	typ Φ_r	5.8	4.7	7.9	W
Dominant Wavelength ⁴	typ λ_d	624	528	464	nm
Color Saturation ^{5,6}	typ	1.00	0.83	0.99	
FWHM - Spectral bandwidth at 50% of Φ_V	typ $\Delta\lambda_d$	19	39	25	nm
Chromaticity Coordinates ^{5,6}	typ x	0.698	0.183	0.141	
	typ y	0.301	0.703	0.044	
Forward Voltage	min V_{Fmin}	2.0	3.1	3.1	V
	typ V_F	2.3	4.4	4.4	V
	max V_{Fmax}	3.0	5.3	5.3	V
Dynamic Resistance	typ Ω_{dyn}	0.02	0.03	0.02	Ω
Characteristics at recommended Pulsed Drive Current I_F^{1,7}					
Reference Duty Cycle ⁸		25	50	25	%
Recommended Peak Drive Current ²	typ I_F	30	30	30	A
Peak Luminous Flux ³	typ Φ_V	1800	3500	600	lm
Peak Radiometric Flux ³	typ Φ_r	10.4	7.2	12.0	W
Dominant Wavelength ⁴	typ λ_d	623	525	462	nm
FWHM - Spectral bandwidth at 50% of Φ_V	typ $\Delta\lambda_d$	19	39	26	nm
Color Saturation ^{5,6}	typ	1.00	0.79	0.99	
Chromaticity Coordinates ^{5,6}	typ x	0.697	0.171	0.144	
	typ y	0.303	0.702	0.040	
Forward Voltage	min V_{Fmin}	2.2	3.5	3.5	V
	typ V_F	2.6	4.9	4.9	V
	max V_{Fmax}	3.4	5.9	5.9	V
Dynamic Resistance	typ Ω_{dyn}	0.02	0.03	0.02	Ω

Optical and Electrical Characteristics

	Symbol	Red	Green	Blue	Unit
Common Characteristics CW/Pulsed					
Thermal Coefficient of Photometric Flux	typ	-1.1	-0.2	-0	% / °C
Thermal Coefficient of Radiometric Flux	typ	-0.7	-0.2	-0.2	% / °C
Forward Voltage Temperature Coefficient	typ	-3.0	-3.0	-3.0	mV / °C
Median Lifetime ⁹		>60,000	>60,000	>60,000	Hours

Note 1: All ratings are based on operation with a constant heat sink temperature $T_{hs} = 40^{\circ}\text{C}$. See Thermal Resistance section for T_{hs} definition.

Note 2: Luminus PhlatLight LEDs are designed for operation to an absolute maximum forward drive current density of $2.5\text{A}/\text{mm}^2$ cw, and $3\text{A}/\text{mm}^2$ pulsed ($f > 240\text{Hz}$, duty cycle $< 60\%$). Please refer to absolute maximum rating table below for specific absolute maximum currents for the products covered in this datasheet. Product lifetime data is specified at recommended forward drive currents. Sustained operation at absolute maximum currents will result in a reduction of device lifetime compared to recommended forward drive currents. Actual device lifetimes will also depend on junction temperature. Refer to the lifetime derating curves (available from Luminus) for further information.

2
3
4
In pulsed operation, rise time from 10 to 90% of forward current should be larger than 0.5 microseconds.

Note 3: Total flux from emitting area at typical dominant wavelength

Note 4: Minimum and Maximum Dominant Wavelengths are based on typical values $+7/-4\text{ nm}$ for Red, $+10/-9\text{ nm}$ for Green and $+/-7\text{ nm}$ for Blue

Note 5: In CIE 1931 chromaticity diagram coordinates, normalized to $X+Y+Z=1$

Note 6: For Reference only

Note 7: Parameters rated at typical duty cycle and Pulsed operation frequency $f > 240\text{Hz}$;

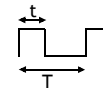
$$DC = \frac{t}{T}$$

Note 8: Duty Cycle used to specify device ratings under Pulsed operation. PhlatLight[®] devices can operate at duty cycles ranging from 1% to 100%. At higher duty cycles, drive current should be adjusted to maintain the junction temperature at desired levels to meet the application lifetime requirements.

Note 9: Assuming $T_j < 80^{\circ}\text{C}$ for Red devices, $T_j < 115^{\circ}\text{C}$ for Blue devices and $T_j < 125^{\circ}\text{C}$ for Green devices.

Absolute Maximum Ratings

	Symbol	Red	Green	Blue	Unit
Maximum Current ¹	Max I_{Fmax}	36	36	36	A
Maximum Operating Junction Temperature ²	Max T_{jmax}	125	150	150	°C
Storage Temperature Range		-40/+100	-40/+100	-40/+100	°C

Note 1: See Note 2, above.

Note 2: Sustained operation at T_{jmax} may result in reduced device life time.

Luminous Flux variation with Wavelength: $\Phi_v = f(\lambda_d)$ at Recommended Operating Current I_F

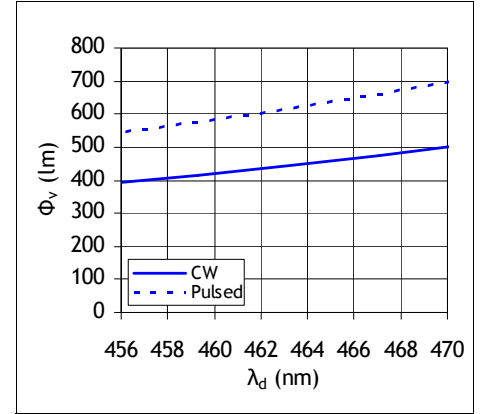
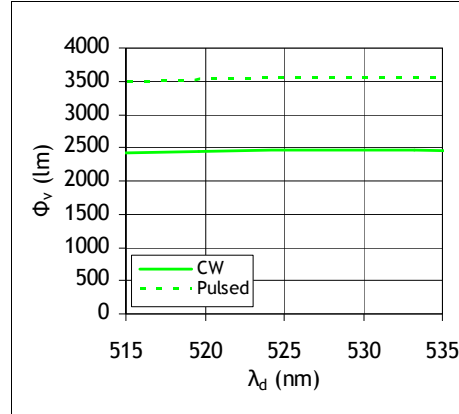
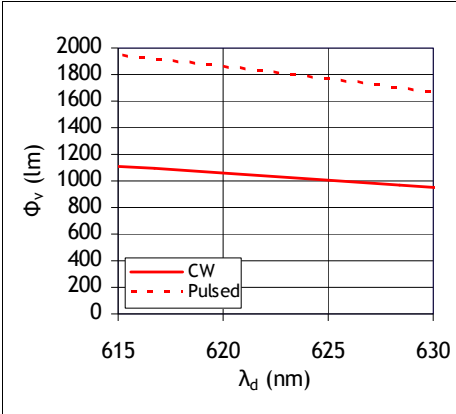

See note 1 on page 5.

Luminous Flux variation with Drive Current - $\Phi_v = f(I_F)$ - Typical

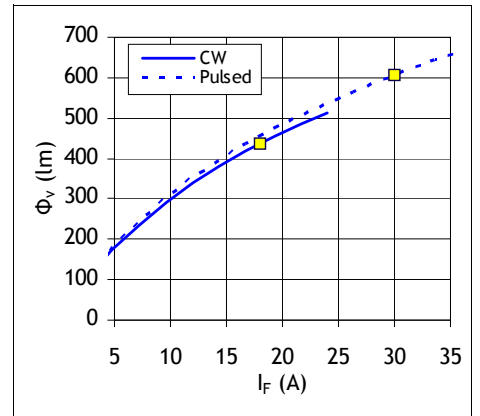
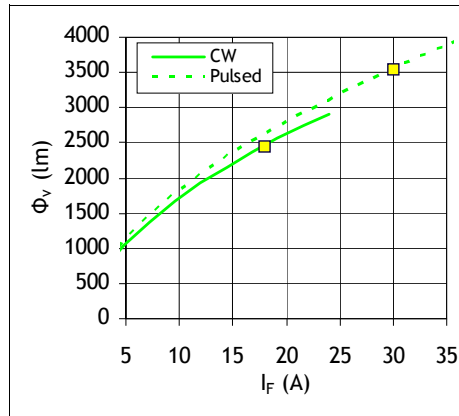
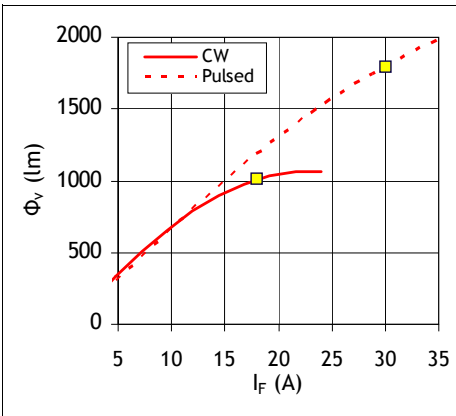

See notes 1,2 on page 5.

Dominant Wavelength variation with Forward Current - $\lambda_d = f(I_F)$ - Typical

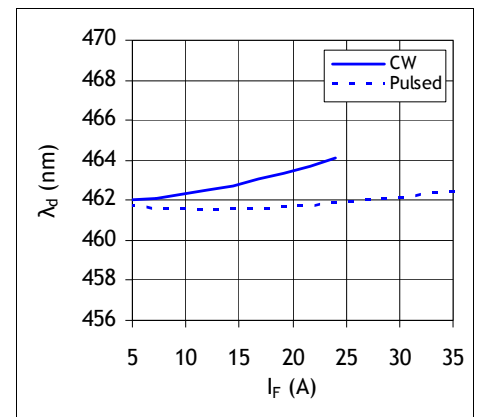
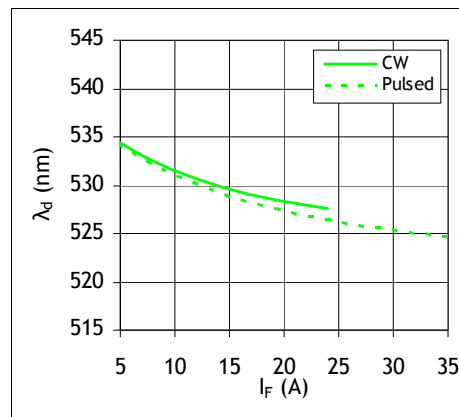
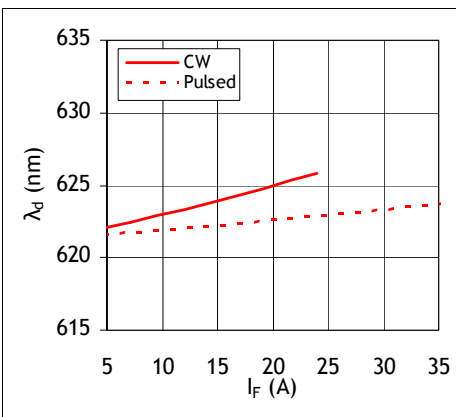

See notes 1,2 on page 5.

Forward Voltage variation with Drive current - $V_F = f(I_F)$ - Typical

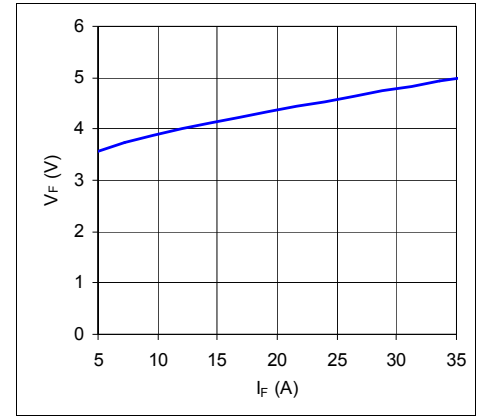
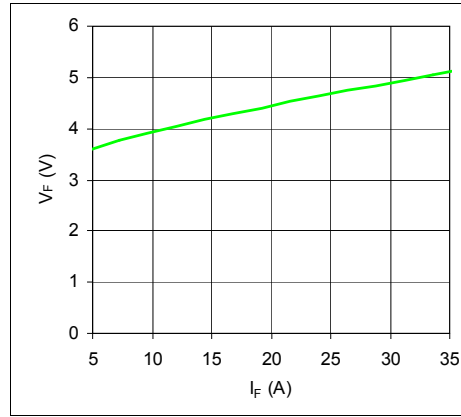
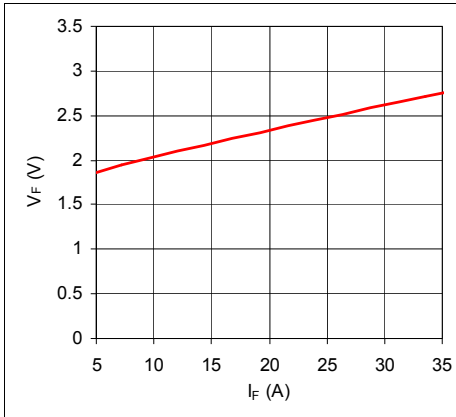

Optical Spectrum (Typical)

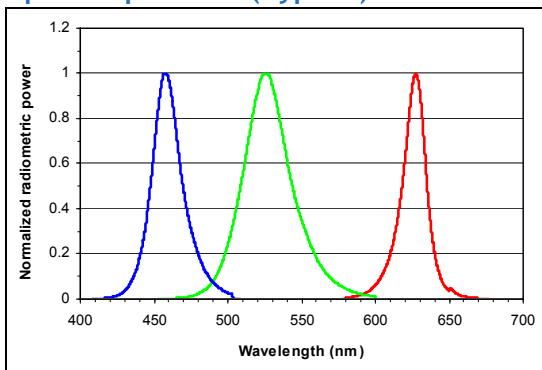

See note 3 on page 5.

Chart Notes

- Note 1: For Pulsed operation, typical RGB duty cycles used are 25%, 50% and 25% respectively for pulsed operation ($T_{hs}=40^{\circ}C$).
- Note 2: Yellow square indicate device operating point under recommended conditions listed in the Optical and Electrical Characteristics table.
- Note 3: Typical Spectrum at recommended peak drive current.

Thermal Resistance

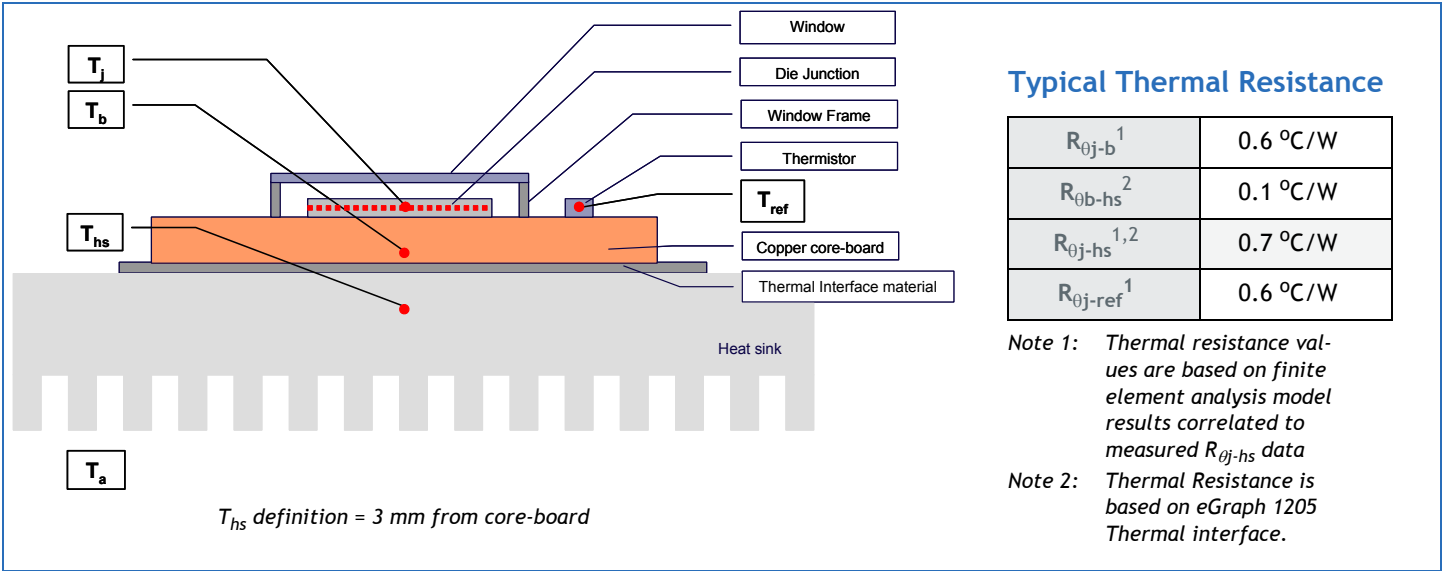

Thermistor Information

The thermistor used in PhlatLight[®] devices mounted on core-boards is from Murata Manufacturing Co. The global part number is NCP15XH103J03RC. Please see <http://www.murata.com/> or <http://www.murata.co.jp> for details on calculating thermistor temperature.

Electrical Pinout

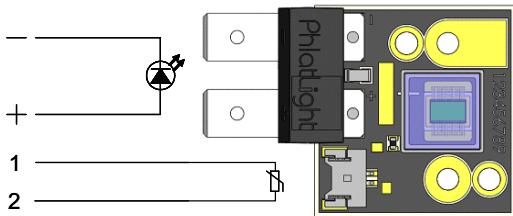

Mechanical Dimensions

Package: Type CX

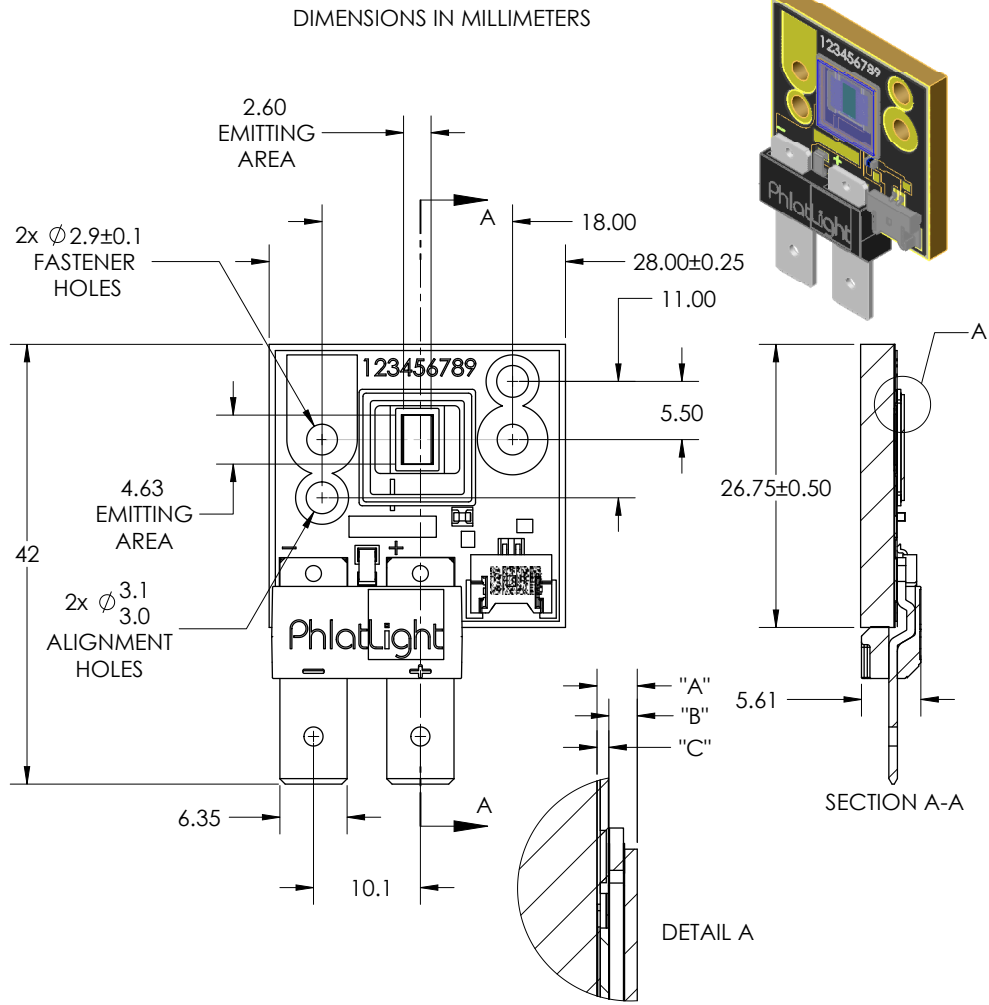

DIMENSION NAME	DESCRIPTION	NOMINAL DIMENSION	TOLERANCE
"A"	TOP OF METAL SUBSTRATE TO TOP OF GLASS	0.95	±0.13
"B"	EMITTING AREA TO TOP OF GLASS	0.67	±0.16
"C"	TOP OF METAL SUBSTRATE TO EMITTING AREA	0.28	±0.05

Recommended connector for Anode and Cathode: Panduit Disco Lok™ Series P/N: DNG14-250FL-C or equivalent
 Thermistor Connector: MOLEX P/N 53780-0270. Recommended Female: MOLEX P/N 51146-0200 or equivalent
 For detailed drawing of PT120 Type CX package, please refer to DWG-001124 document

Ordering Information

Device Part Number	Color	Description
PT-120-R-C11-KITSAMPLE	Red	Red PhlatLight PT120 consisting of a 12mm ² LED, thermistor and connector mounted on a type CX copper-core PCB.
PT-120-G-C11-KITSAMPLE	Green	Green PhlatLight PT120 consisting of a 12mm ² LED, thermistor and connector mounted on a type CX copper-core PCB.
PT-120-B-C11-KITSAMPLE	Blue	Blue PhlatLight PT120 consisting of a 12mm ² LED, thermistor and connector mounted on a type CX copper-core PCB.

www.luminus.com

The products, their specifications and other information appearing in this document are subject to change by Luminus Devices without notice. Luminus Devices assumes no liability for errors that may appear in this document, and no liability otherwise arising from the application or use of the product or information contained herein. None of the information provided herein should be considered to be a representation of the fitness or suitability of the product for any particular application or as any other form of warranty. Luminus Devices' product warranties are limited to only such warranties as accompany a purchase contract or purchase order for such products. Nothing herein is to be construed as constituting an additional warranty. No information contained in this publication may be considered as a waiver by Luminus Devices of any intellectual property rights that Luminus Devices may have in such information. PhlatLight[®] is a registered trademark of Luminus Devices, Inc., all rights reserved.

This product is protected by U.S. Patents 6,831,302; 7,074,631; 7,083,993; 7,084,434; 7,098,589; 7,105,861; 7,138,666; 7,166,870; 7,166,871; 7,170,100; 7,196,354; 7,211,831; 7,262,550; 7,274,043; 7,301,271; 7,341,880; 7,344,903; 7,345,416; 7,348,603; 7,388,233; 7,391,059; Patents Pending in the U.S. and other countries.